



**krede**

**krede** | chair collection



**krede**

[www.krede.co.kr](http://www.krede.co.kr)

**HEAD OFFICE** A417, 25, Beobwon-ro 11-gil, Songpa-gu, Seoul, Korea T 82 2 6254 5432 F 82 2 6254 5433 [sales@krede.co.kr](mailto:sales@krede.co.kr)

sit in joy. **krede**

**krede [kredi:]**



**krede**

sit in joy. **krede**



# krede

## creative , design

### krede [kredi:]

Only when working with a good chair,  
you can have the power to immerse yourself in creating new opportunities.  
“krede” was born as a result of the long design and research on “seating”.  
The design philosophy of “krede” is to make a chair that is faithful to the basics.  
If you are looking for a good chair, there is “krede”

sit in joy, krede

### design JOYN

krede CEO Cho YoonHa (JOYN) is the representative chair designer in Korea.  
The products designed by JOYN changed the paradigm of overall Korean chair design,  
and JOYN has shown the way the brand should go by his own products.  
“krede” will show its value  
by concentrating on what the users really want more than the designer's own angle,  
also aiming for superior comfort and beauty better than anyone else.

### UZUO

“krede” goes with “UZUO”, one of the best chair manufacturers in China.  
A total of 220,000m<sup>2</sup> scale factory has 80 injection machines,  
and this factory produces all parts to ensure a consistent quality of over 300,000EA per a month.  
Also, all products are managed by strict test level higher than BIFMA through its own test lab.

### “krede”

will offer you a new pleasure of “seating”  
by the advanced design that the user wants  
and superior quality products  
with honest price.



# K10

Combining the latest in comfort and technology, K10 offers easy-to-use features and breathable mesh, delivering the most comfort and the sustainable quality for long time work.

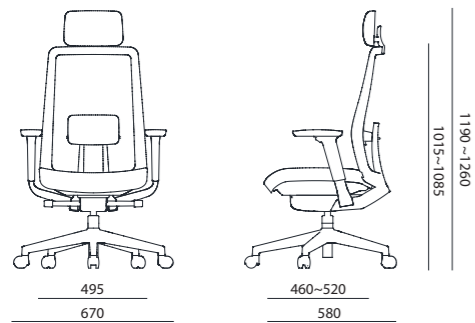

## Outstanding Performer at Workplace, K10

The most advanced synchronized tilting mechanism of K10 realizes the ergonomic ideal of chair synchronizing with user's body in motion. Maximum adjustability with easy handlings of the smartly designed levers completes the highest performance of K10.



# K10

K10 has the most advanced functions such as adjustable headrest with spring tension, 4D armrests, lumbar support, depth adjustable seatrest, etc., to maximize the users' working efficiency.



# K10M

It gives vitality to the space and a pleasant impression.  
K10M chair helps you to focus on productive learning  
and work by providing vitality and comfort to your work.

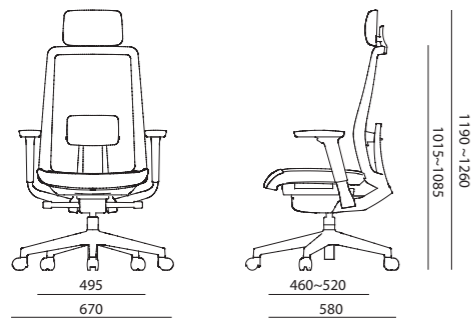





### User-Friendly Sitting Experience, K10M

K10M is another version of K10 with all-mesh task seating for more elastic reaction to frequent posture changing and various body type.

K10M offers the ultimate user-friendly sitting experience.

# K10M

## Highly Elastic Soft Mesh

K10M chose highly elastic soft mesh for both backrest and seatrest to provide customized comfort.



## DETAIL & FUNCTION



### 1,2. Adjustable Headrest (Optional)

The headrest is height adjustable, especially, it helps the user's head maintain comfortable position all the time by natural reaction when tilted.

### 3,4. Adjustable Lumbar Support

The lumbar support is height and depth adjustable.

### 5,6. Adjustable Armrest

The armrest is height adjustable depending on user's preference, and it also offers additional forward/backward, left/right and angle adjustment.

### 7. Highly Elastic Soft Mesh

K10M chose highly elastic soft mesh for both backrest and seat to provide customized comfort.

### 8. Adjustable Seat

The depth of seat is adjustable up to 60mm depending on the user's preference.

## VARIATION



**K10A (BK)  
K10A-BS (WH)**  
2-Way Adjustable Headrest  
Adjustable Armrest (4D)  
2-Way Adjustable Lumbar Support  
Depth Adjustable Seatrest  
Synchronized Tilt Mechanism  
Engineering Plastic Base  
Urethane Casters  
720 x 580 x 1190



**K10B (BK)  
K10B-BS (WH)**  
Adjustable Armrest (4D)  
2-Way Adjustable Lumbar Support  
Depth Adjustable Seatrest  
Synchronized Tilt Mechanism  
Engineering Plastic Base  
Urethane Casters  
720 x 580 x 1015



**K10A-QW (BK)  
K10A-QW-BS (WH)**  
2-Way Adjustable Headrest  
Adjustable Armrest (4D)  
2-Way Adjustable Lumbar Support  
Depth Adjustable Mesh Seatrest  
Synchronized Tilt Mechanism  
Engineering Plastic Base  
Urethane Casters  
720 x 580 x 1190



**K10B-QW (BK)  
K10B-QW-BS (WH)**  
Adjustable Armrest (4D)  
2-Way Adjustable Lumbar Support  
Depth Adjustable Mesh Seatrest  
Synchronized Tilt Mechanism  
Engineering Plastic Base  
Urethane Casters  
720 x 580 x 1015

## STANDARD COLOR & FINISHES

### K10

#### Body | Plastic



WHITE

BLACK

#### Headrest | A. Leather

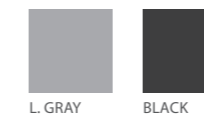

L. GRAY

BLACK

#### Backrest | Mesh

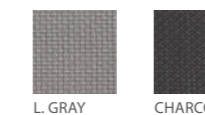

L. GRAY

CHARCOAL

#### Seatrest | Fabric

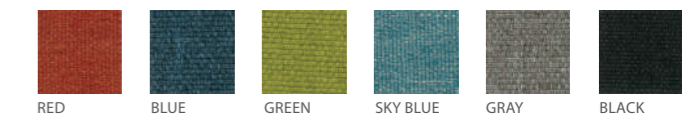

RED

BLUE

GREEN

SKY BLUE

GRAY

BLACK

### K10M

#### Body | Plastic



WHITE

BLACK

#### Headrest | A. leather



L. GRAY

BLACK

#### Backrest, Seatrest | Mesh



SAMBA RED

DUSTY BLUE

LEAF GREEN

MINERAL

CHARCOAL

# K20

krede will satisfy clients' needs in every possible way.  
K20 is the best chair which meets the most with the least.

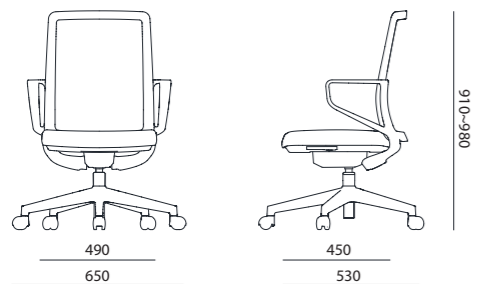



### Simple Is the Best, K20

K20 is a smart task chair engineered to provide the most comfortable support for every user, as well as offering simplicity and complete ease of use. Minimal adjustments provide ease of use for improved user comfort.

# K20

## Brilliant Teamwork with You

K20 provides 2 types of chairs suitable for each different work environment.



## DETAIL & FUNCTION

### Weight Balance Tilt

Without any separate adjustments, K20 feels the weight of each sitter, and control the tension of tilting.

### Hidden Lever

Adjusting levers are hidden in each side of the seat aiming for the apparent simplicity.

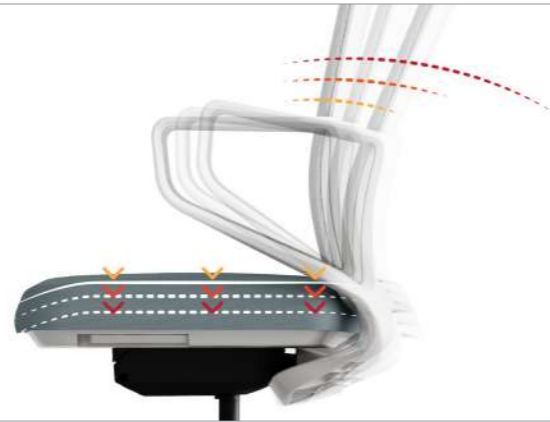

## VARIATION



**K20B-1 (BK)**  
**K20B-1-BS (WH)**

Elastic Mesh Backrest  
Armrest  
Sponge Pad Seat  
Synchronized Tilt Mechanism  
Engineering Plastic Base  
Urethane Caster

680 x 590 x 970(1150)



**K20B-2 (BK)**  
**K20B-2-BS (WH)**

Sponge Pad Backrest  
Armrest  
Sponge Pad Seat  
Synchronized Tilt Mechanism  
Engineering Plastic Base  
Urethane Caster

680 x 590 x 970(1150)

## STANDARD COLOR & FINISHES

### Body | Plastic



WHITE

BLACK

### Backrest | Mesh

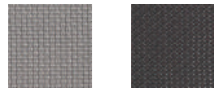

L. GRAY

CHARCOAL

### Backrest, Seatrest | Fabric

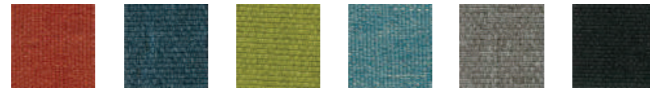

RED

BLUE

GREEN

SKY BLUE

GRAY

BLACK



# K30

Comfort coming to anyone in anywhere.

K30 is comfortable for all different daily multi-users with its minimalist design.

Users can personalize the space by choosing various finishing colors.

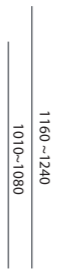
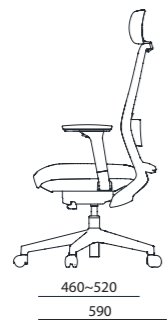
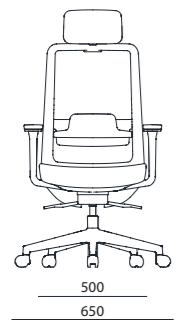



## Support Your Body, Support Your Work, K30

K30 provides sophisticated ergonomic seating at optimal value.

With its clean lines, K30 blends seamlessly in any facility.





### Weight Balance Tilt

Without any separate adjustments, K30 feels the weight of each sitter, and control the tension of tilting.



# K30

## Gift for Your Office and Home

Even with its advanced functions like weight-balance tilt or 3D armrests, the honest price goes to you just like a Christmas gift.



**DETAIL & FUNCTION**



**1. Adjustable Headrest (Optional)**

The headrest is height adjustable to help the user's head maintain comfortable position.

**2,3. Adjustable Armrest**

The armrest is height adjustable depending on user's preference, and it also offers additional forward/backward and angle adjustment.

**4,5. Adjustable Lumbar Support**

The lumbar support is height adjustable, and the supporting pad is naturally joined with body.

**6. Adjustable Seat**

The depth of seat is adjustable (forward/backward) depending on user's preference.

**7. Self Weight Adjusting Mechanism**

Tilting tension of backrest is automatically adjusted according to the user's weight, and the backrest offers 4-level tilting angle adjustment for optimal comfort.

**8. Base & Caster**

K30 is using engineering plastic starbase and urethane casters.

**VARIATION**



**K30A (BK)  
K30A-BS (WH)**  
Adjustable Headrest  
Adjustable Armrest (3D)  
Adjustable Lumbar Support  
Depth Adjustable Seatrest  
Synchronized Tilt Mechanism  
Engineering Plastic Base  
Urethane Casters  
650 x 590 x 1160



**K30B (BK)  
K30B-BS (WH)**  
Adjustable Armrest (3D)  
Adjustable Lumbar Support  
Depth Adjustable Seatrest  
Synchronized Tilt Mechanism  
Engineering Plastic Base  
Urethane Casters  
650 x 590 x 1010

**STANDARD COLOR & FINISHES**

**Body Color | Plastic**



**Headrest | A. Leather**

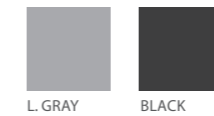

**Backrest | Mesh / Seatrest | Fabric**

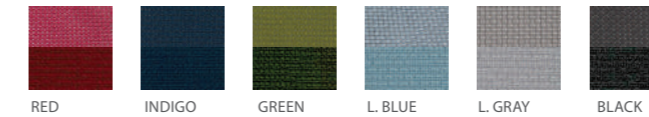

# K50

K50 is designed to create the best with minimal materials.

Double-layer backrest supports the user's body comfortably along with hidden lumbar support.

The backrest mesh of K50 prevents heat rising when seated, so you can use it in more pleasant condition.

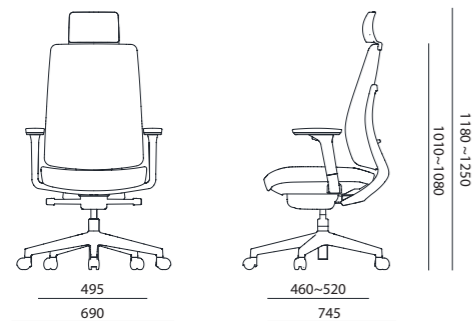

### Futuristic Vision, K50

K50 delivers a personal experience that responds to the unique movements of user's body.

K50 with minimal adjustments provides natural comfort through the tension of characteristic fabric and power of lumbar support.



# K50

## Enjoy the Fun

The integrated seat style exudes an unparalleled sense of exquisite fashion. Open up a comfortable space for you in the office, meditate, have a rest or do nothing, quietly recharge the spirit and enjoy the modern office fun.



# K50

## Futuristic Vision, K50

K50 delivers a personal experience that responds to the unique movements of user's body.

K50 with minimal adjustments provides natural comfort through the tension of the characteristic fabric and the power of lumbar support.





## DETAIL & FUNCTION

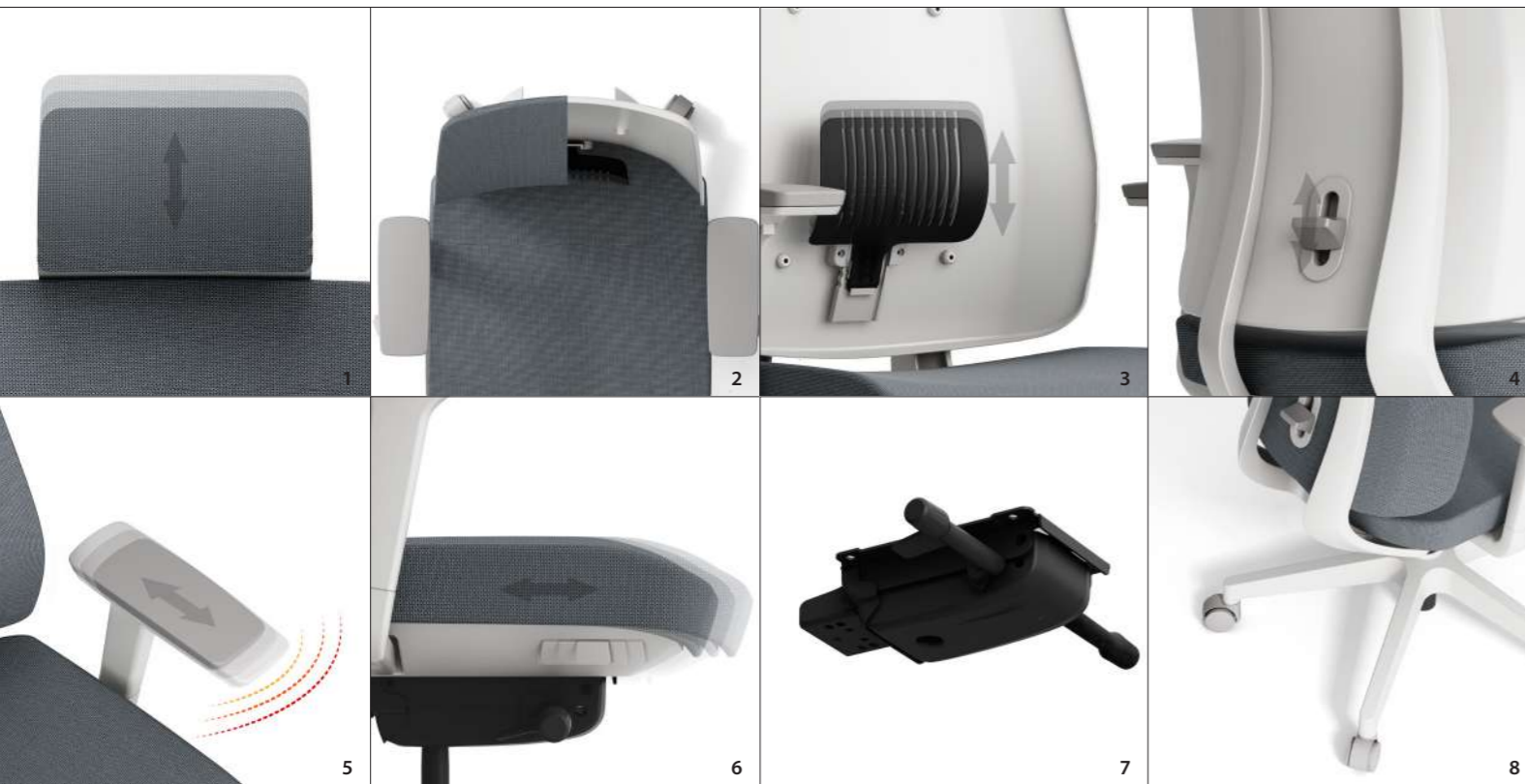

### 1. Adjustable Headrest (Optional)

The headrest is height adjustable to help the user's head maintain comfortable position.

### 2~4. Adjustable Lumbar Support

The hidden lumbar support is height adjustable, and the supporting pad is naturally joined with body.

### 5. Adjustable Armrest

The armrest is height adjustable depending on user's preference, and it also offers additional forward/backward and angle adjustment.

### 6. Adjustable Seat

The depth of seat is adjustable (forward/backward) depending on user's preference.

### 7. Synchronized Tilt Mechanism

K50 offers optimal seating comfort by offering 4-level tilting angle adjustment and easy control of tilting tension.

### 8. Base & Caster

K50 is using engineering plastic starbase and urethane casters.

## VARIATION



### K50A (BK) K50A-BS (WH)

Adjustable Headrest  
Adjustable Armrest (3D)  
Adjustable Lumbar Support  
Depth Adjustable Seatrest  
Synchronized Tilt Mechanism  
Engineering Plastic Base  
Urethane Casters  
690 x 740 x 1245



### K50B (BK) K50B-BS (WH)

Adjustable Armrest (3D)  
Adjustable Lumbar Support  
Depth Adjustable Seatrest  
Synchronized Tilt Mechanism  
Engineering Plastic Base  
Urethane Casters  
690 x 740 x 1080

## STANDARD COLOR & FINISHES

### Body Color / Plastic



### Headrest, Backrest, Seatrest | Fabric

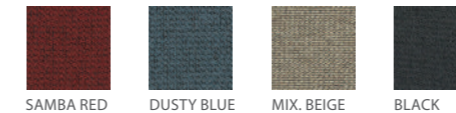

# R30

The unibody makes the chair very light.  
It can be easily stacked, and easily moved.  
R30 is a very light chair.

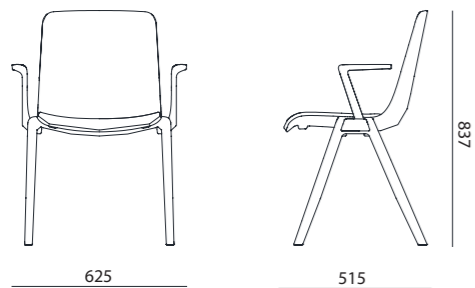

### Creat your space, R30

R30 is designed to offer a unique, minimal aesthetic and to provide optimal comfort for every person who sits in it.





# R30

## Back to the Multi-Purpose Chair

R30 focuses on the natural duty of multi-purpose chair,  
simple design with various options,  
but with the lowest price range.



**DETAIL & FUNCTION**



**CONNECTOR**

It is useful when the chairs need to be placed at regular intervals. Depending on the specification of armrest, the chairs can be placed at doubled intervals.

**TABLET**

The tablet of R30 can be used as a small table, and is foldable when it is not used.

**VARIATION**

**R30 (BK)  
R30-BS (WH)**

Armless  
Seat Pad  
Urethane Glides



534 x 515 x 837

**R30-1 (BK)  
R30-1-BS (WH)**

Armrest  
Seat Pad  
Urethane Glides



625 x 515 x 837

**R30-X (BK)  
R30-X-BS (WH)**

Tablet  
Seat Pad  
Urethane Glides



637 x 635 x 837

**STANDARD COLOR & FINISHES**

**Body | Plastic**



WHITE

BLACK

**Seat Pad | Fabric**

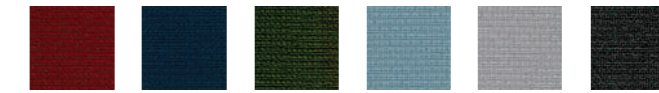

RED

INDIGO

GREEN

BLUE GRAY

L. GRAY

BLACK

# R40

The easy-to-carry chair, R40, is convenient to move, and can be placed anywhere, which makes it easy to use at either normal or temporary situation.

Nesting structure makes space allocation a lot easier, and its light weight gives such high convenience to both users and space manager.

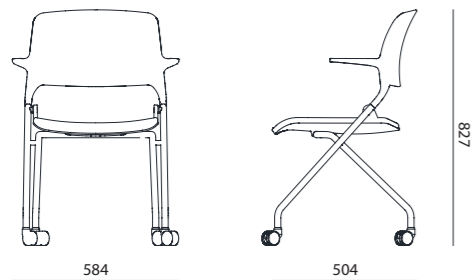

## Free Your Body, R40

R40 is the perfect addition to your multi-purpose or training space. The seat flips up to allow chairs to nest in neat, compact rows when not in use. Fixed arms provide upper body support, which is especially valuable during long meetings.







## DETAIL & FUNCTION

### Nesting

Nesting of R40 by folding up the seat offers easy handling and storage.



## VARIATION



R40 (BK)  
R40-BS (WH)

Armrest  
Seat Pad  
Casters

584 x 504 x 827



R40-1 (BK)  
R40-1-BS (WH)

Armrest  
Seat Pad  
Glides

584 x 504 x 827

## STANDARD COLOR & FINISHES

Body | Plastic



WHITE

BLACK

Seat Pad | Fabric

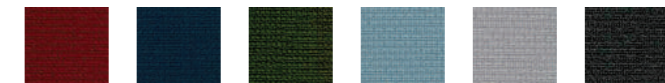

RED

INDIGO

GREEN

BLUE GRAY

L. GRAY

BLACK

SERIES



# krede

주 | 크레디  
KREDE CO., LTD.

**HEAD OFFICE**

A417, 25, Beobwon-ro 11gil, Songpa, Seoul, Korea  
T +82. 2. 6254. 5432  
F +82. 2. 6254. 5433  
sales@krede.co.kr

[www.krede.co.kr](http://www.krede.co.kr)

\*The images in this catalog can differ from the actual product.  
Please confirm the actual product before purchase.

\*The dimension and design indicated here are subject to change depending on situations  
involved with product design and manufacturing.



# krede